

**koldpack**<sup>®</sup>  
*filling & packaging technology*

**bestech**<sup>®</sup>  
*water treatment experts*



**kb** *Associates*

**Empowering Liquid Packaging**

## **What we are.....**

**“kb Associates”** a name that is embarked in the market for its expertise to provide end-to-end solutions for liquid processing and packaging. Catering an entire range of equipments developed and produced by a young and energetic team of people having rich experience of around one and half decades, kb Associates has carved a niche in domestic and inter market.

Perceiving a vision to make liquid packaging the most sophisticated and competitive, kb Associates is impel to excel. With its comprehensive range of in line equipment for varied applications of washing, filling, sealing, labeling, conveying, inspection. kb Associates is determined to serve any latest need of the industry.

# Empowering Liquid Packaging

## **Establishment**

Founders of the kb Associates are entrepreneur engaged in development and manufacturing of various equipments related to liquid packaging With an aim to serve perfect solution of packaging and water treatment solution in market.

Established in 2004, we "Koldpack" are leading Manufacturer, and Exporter of a wide range of liquid packaging machine to serve in industries like Food & Beverages, Cosmetics, Distilleries, Pesticides etc.

Established in 1997, we "Bestech" are leading Manufacturer, and Exporter of a wide range of industrially developed and custom designed Water Treatment Plants such as Bottle Filling Machines, Packaging Machine, Water Distillation Plant and Many more.

**Empowering Liquid Packaging**

## Infrastructure :

Located In **Ahmedabad**, an industrial heart of **India** and having its operations in all corners of the country.

Our manufacturing facilities spread over around 10000 Sq. Ft. Each facility is operating as an individual entity and contributing in the growth of kb Associates with separate development and manufacturing.



In house R&D section, Fabrication and Machine Shop using most modern machines and methods, QC department equipped with latest instruments, Online Assembly shop etc is giving kb associates an edge over its competitors.

# Empowering Liquid Packaging

## Organizational Structure

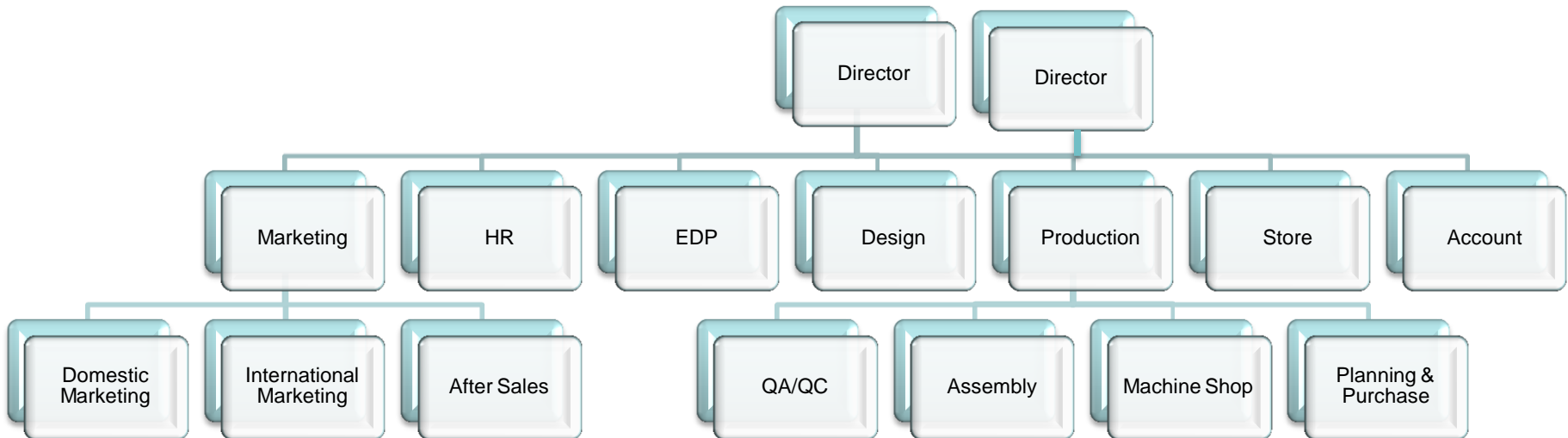

Empowering Liquid Packaging

## **Strength :**

A devotional team of almost over 50 people is the core strength of the organization. A tuned team of around 25 engineers in various departments of the company and an active group of around 20 marketing and customer support executives lead by 5 visionary top management people is the driving force of the company.

At the heart of our success is our 50+ strong team of engineers, technicians, marketers and customer relationship professionals, who dedicate their willingness and expertise to make sure that customers are kept happy, round the clock, around the globe. With further expansion and product development in the pipeline, and our talent and its unwavering customer-centricity, we are confident of sustaining the high growth we have achieved in the past few years.

# Empowering Liquid Packaging

## **Product Portfolio**

### **Products for Turn-key projects for all Beverages**

- Reverse Osmosis Plants ( R.O.Plants)
- High Speed Rinsing Filling & Capping Machines (For Mineral Water and Beverages)
- Volumetric Liquid Filling Machines
- Flow Meter Based Bulk Filling Machines (For Barrel , Cans, IBC)
- Cap Sealing Machines
- Rotary Filling & Sealing Machines
- High Speed Gum Labeling Machines
- BOPP Labeling Machine
- Sleeve Labeling Machine
- Eye-Ear Drop Filling- Plugging- Screw Capping Machines
- Turn Tables ( Scrambler – Unscramblers)
- Conveyors
- Visual Bottle Inspection Machines

### **Products under development**

- High Speed Unscrambler
- High Speed Rotary E Fill Machine
- High Speed jar Filling Machine

**Empowering Liquid Packaging**



**Barrel And  
Can Filling**

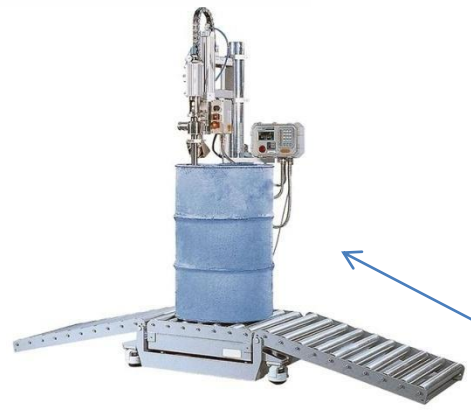

Barrel Filling Machine



Barrel Filling Machine



Multi Drum Filling and Capping Machine  
– Camera Based

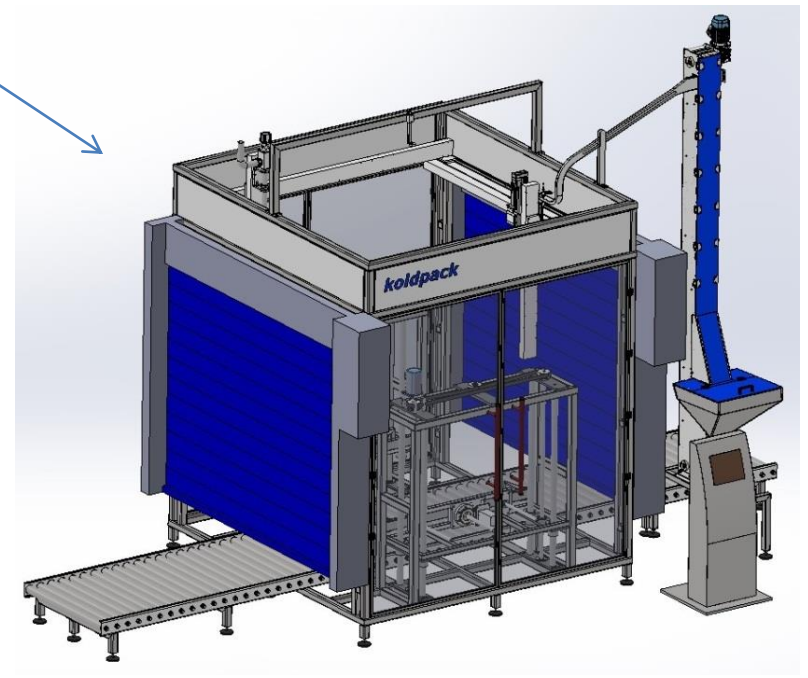

Multi Layer Cans and Multi Drum Filling and Capping Machine  
– Camera Based

**Empowering Liquid Packaging**





Bag in Box Filling Machine



20 Liter Jar Filling Machine

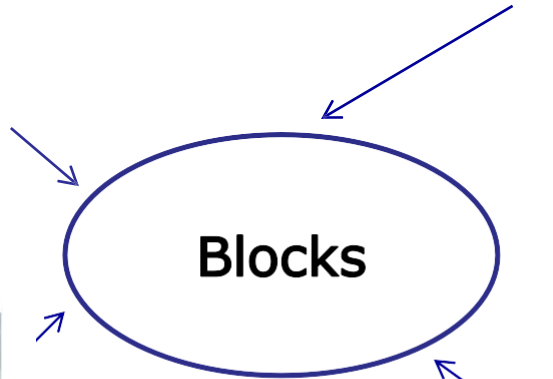

**Blocks**



Rinsing Filling & Capping Machine



High Speed Rinsing Filling & Capping Machine

# Empowering Liquid Packaging



UF Plant



Industrial FRP RO Water Plant

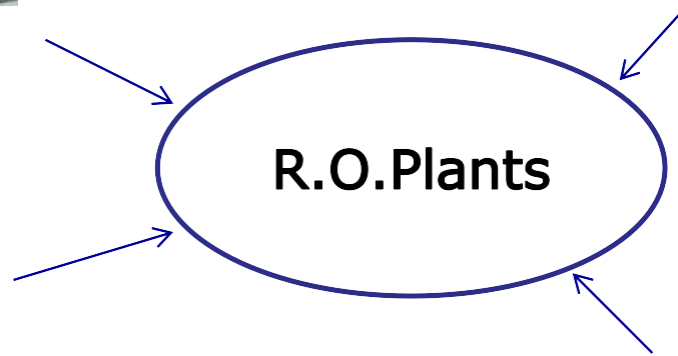

**R.O.Plants**



Industrial SS RO Water Plant



Industrial SS RO Water Plant

**Empowering Liquid Packaging**



Linear Washer with robotic arms



Tunnel Type Liner Washer



Rotary Bottle Washing Machines



Vertical Air jet Cleaning Machine



Air jet Cleaning Machine - Inverter Type



**Washing**



Electronic Filling Machine

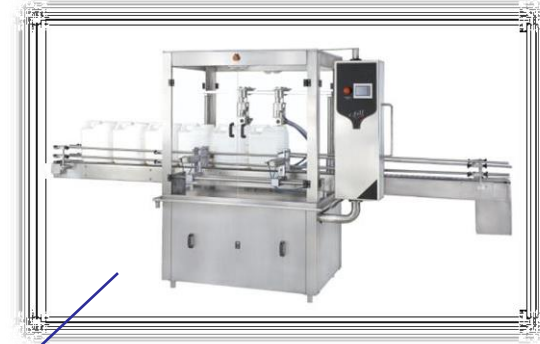

Auto Bulk Filling Machine

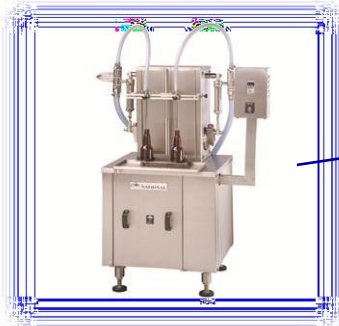

Semi Auto Volumetric Liquid Filling Machine

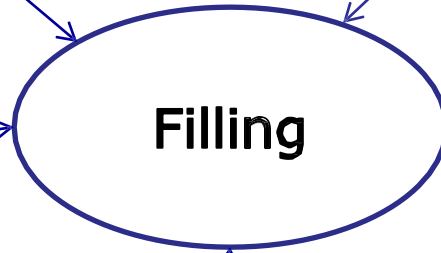

**Filling**



Semi Auto Bulk Filling Machine



Auto Volumetric Filling Machine

**Empowering Liquid Packaging**



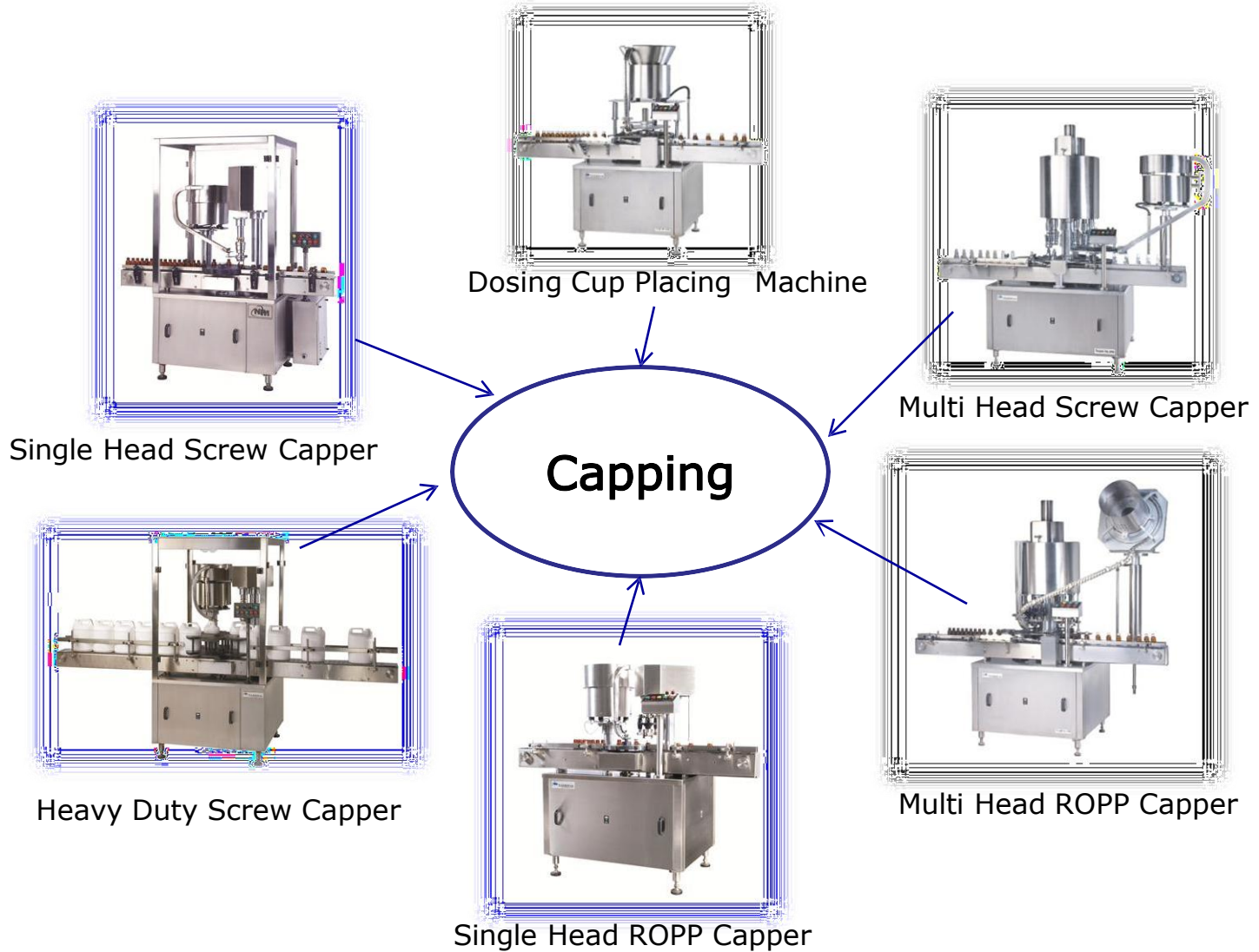

**Empowering Liquid Packaging**



Sleeve Labeling Machine



Gum Labeling Machine



Self Adhesive Labeling Machine



BOPP Labeling Machine

**Empowering Liquid Packaging**



Magnifying Dome Type Inspection

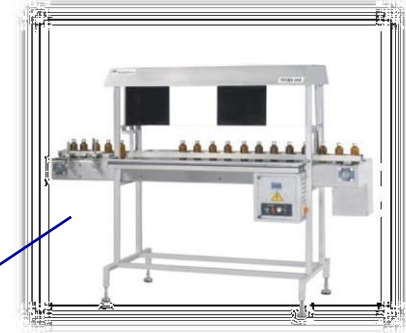

B/W Back Visual Inspection



**Accessories**

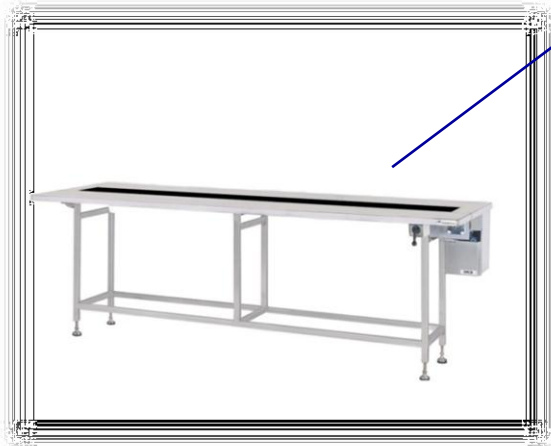

Packing Conveyor



Unscrambler - Scrambler

**Empowering Liquid Packaging**



Successfully Completed Manufacturing and Installation of Turnkey Project  
Patented Machine – Cubitainer Filling And Capping Machine ( Bag In Box )  
Plant Location – Horiba India PVT. Ltd., Nagpur  
Order Value -

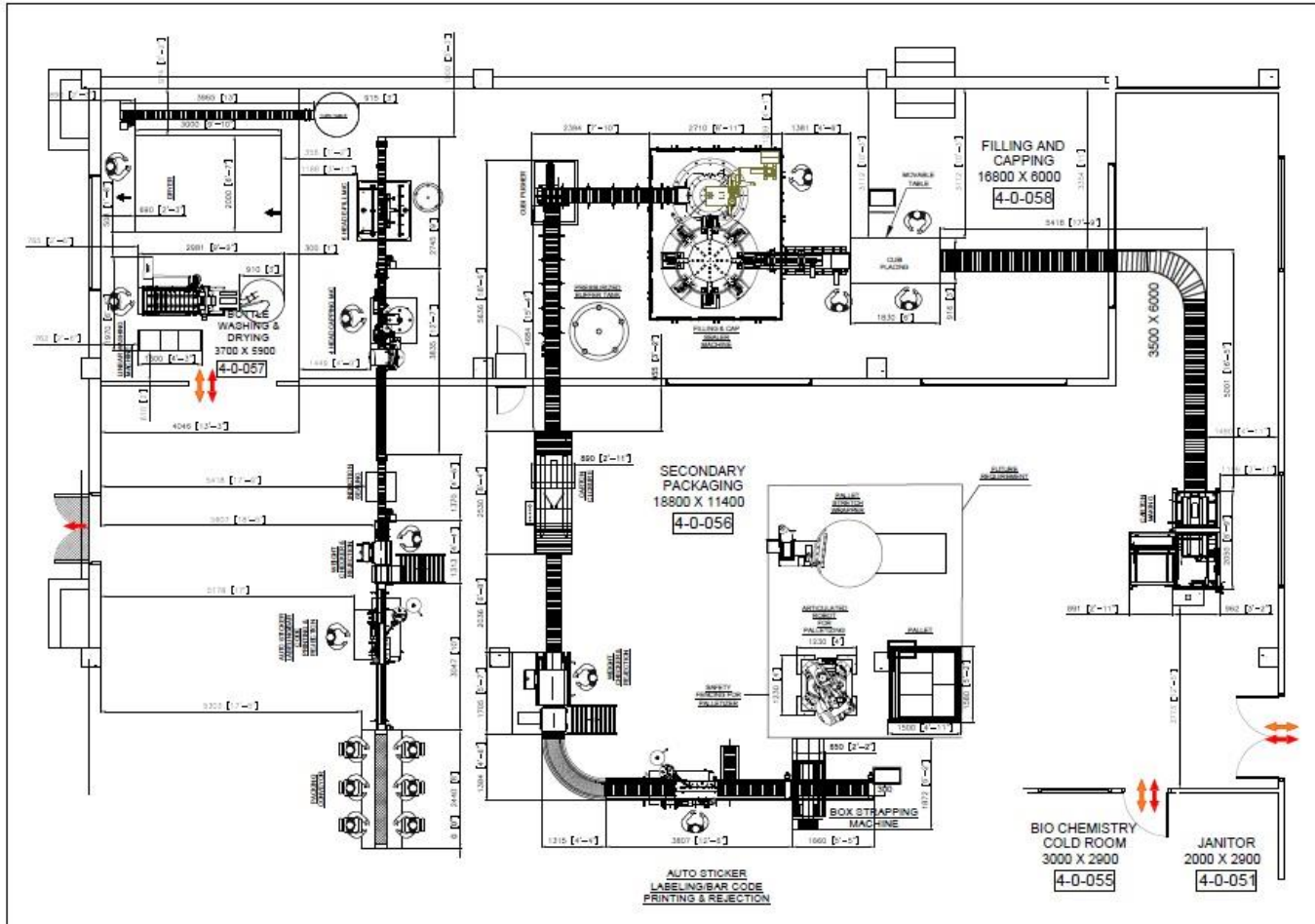

Empowering Liquid Packaging



Successfully Completed Manufacturing and Installation of Turnkey Project for Packaged Drinking Water Bottling Plant .

Plant Location – Kalika Beverages, Ahmedabad, Gujarat

Order Value -

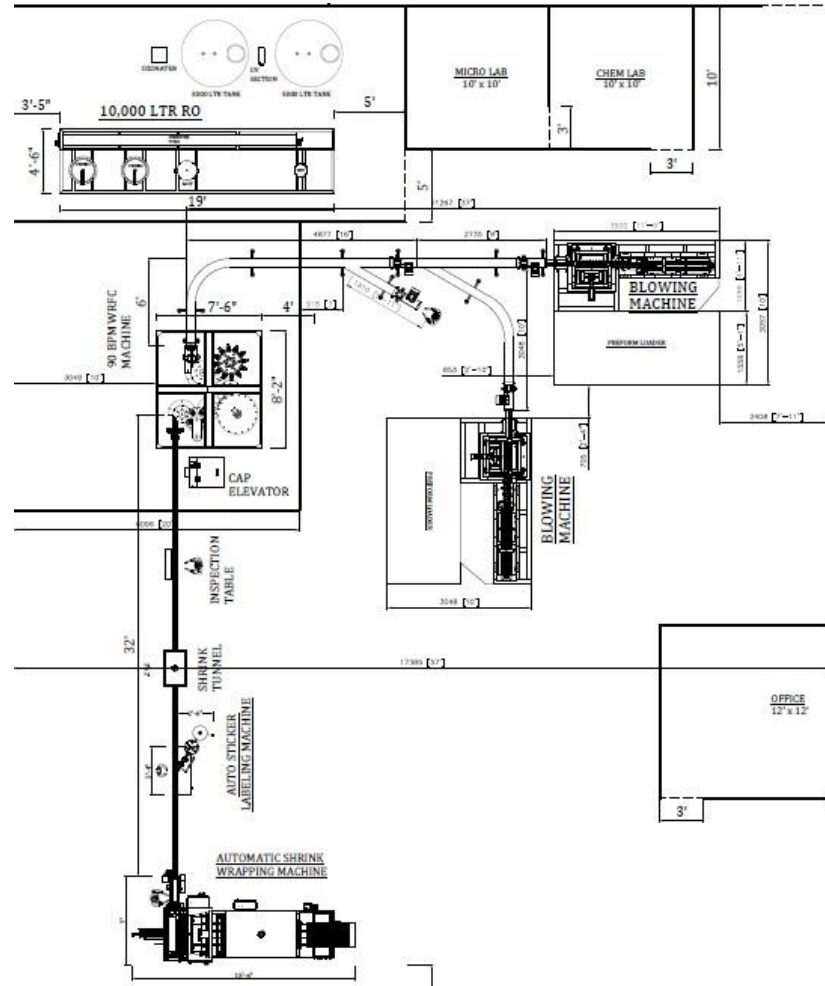

Empowering Liquid Packaging

Successfully Completed Manufacturing and Installation of Turnkey Project for PET Bottle Packaging – Carbonated Soft Drink Plant .

Plant Location – Uganda

Order Value -

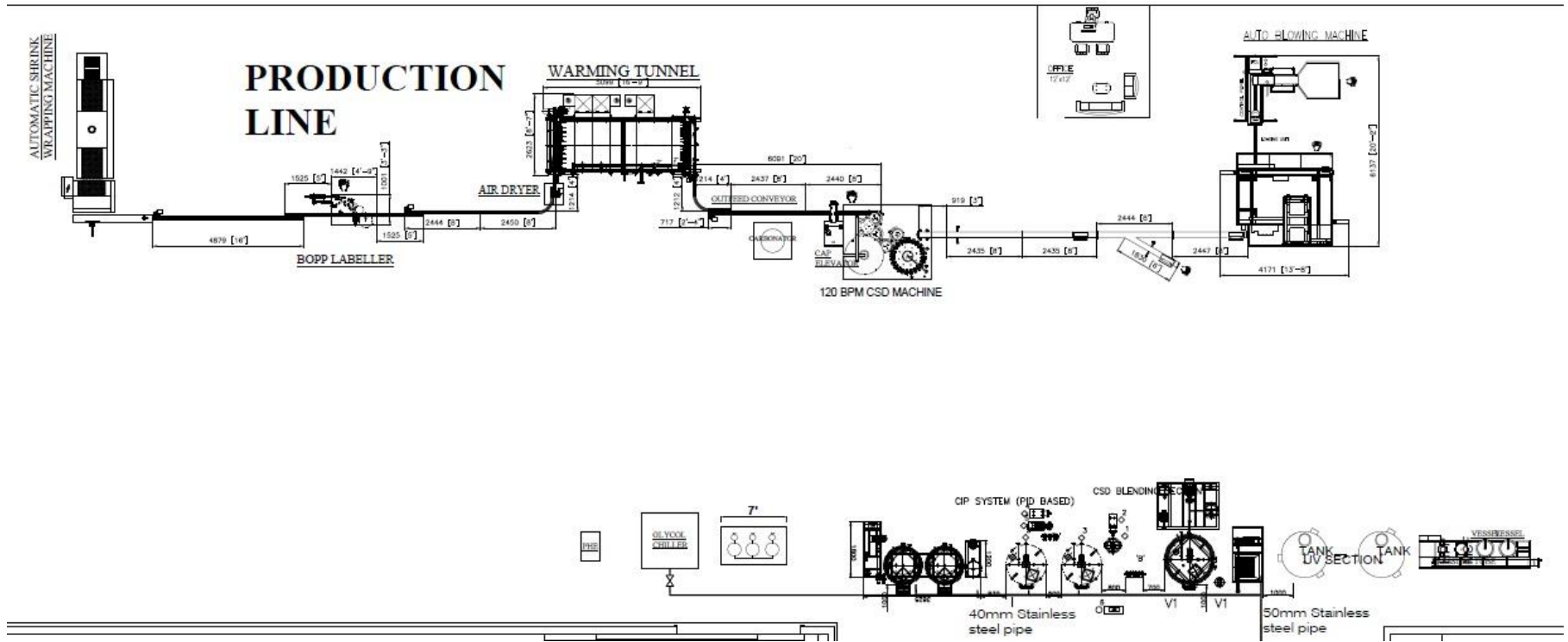

Empowering Liquid Packaging

Successfully Completed Manufacturing and Installation of Turnkey Project Packaged  
Drinking Water Bottling Plant.  
Plant Location – Kenya  
Order Value -

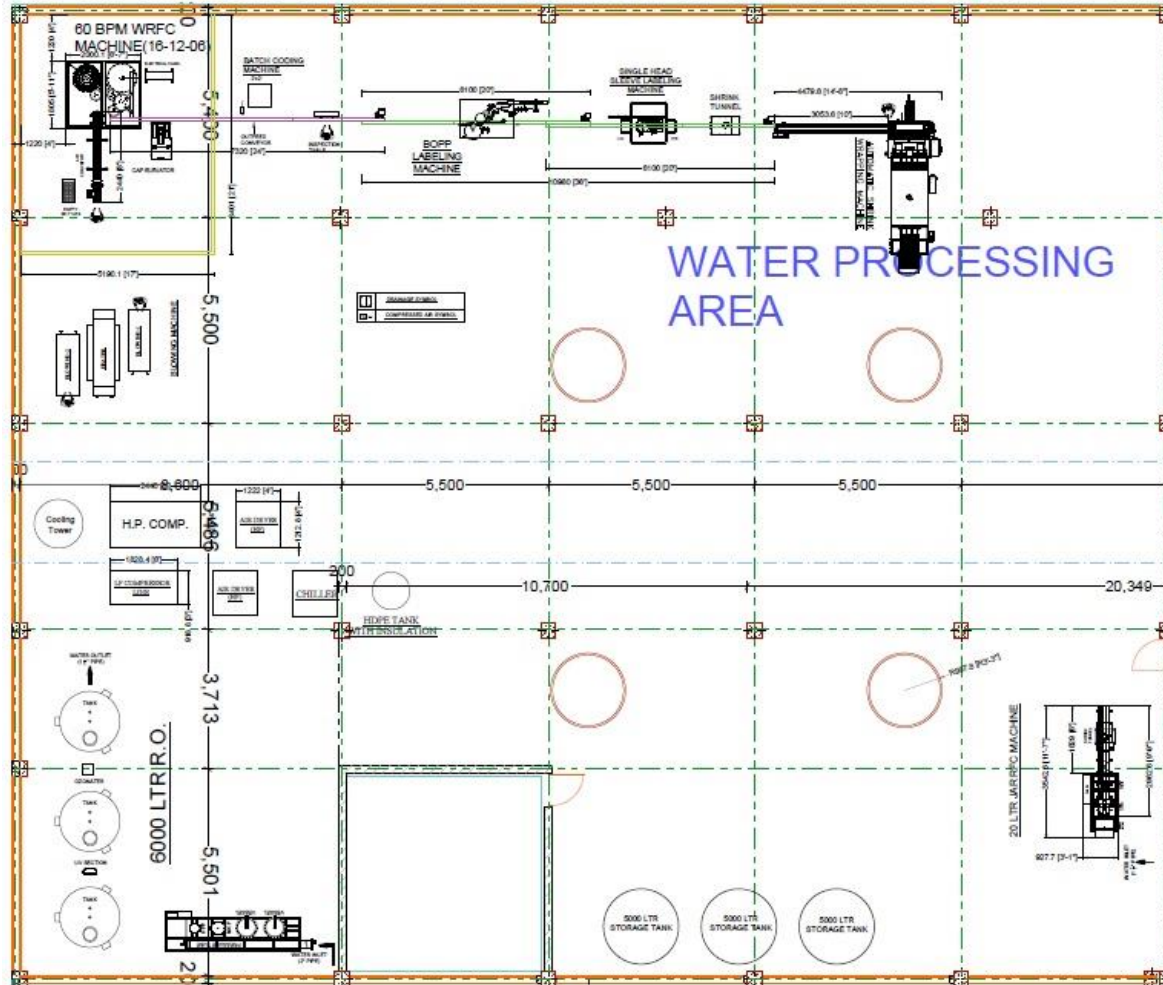

Empowering Liquid Packaging



## Success Story of patented Machine - Camera Based Drum Filling Machine Plant Location – Ireland



Date 27/10/2020

To,  
KB ASSOCIATES,  
11, Varahi Estate,  
Nr. Gota Railway Over Bridge, Gota,  
Ahmedabad - 382481 Gujarat, India

Subject – Performance Certificate

We are pleased to inform you that we have been using Koldpack make Fully Automatic Multi Drum Filling Machine, Model - QUADRA-KMWT25 (Camera Based) in our production plant for Barrel and IBC Packaging.

We are satisfied with the performance of the Filling Machine and after sales support provided by Sales and Service Team and we look forward to receive similar support from Koldpack in Future.

We are sure that ensuring such type of Continuous efforts, will help us to strengthen business relations with Koldpack in future.

Machine Details –

Description	QTY	Filling Volume	Installation Year
Fully Automatic Multi Drum Filling Machine, Model - QUADRA-KMWT25	1 No.	200kg, 210kg, 1000kg	Dec-2019

Yours Faithfully,

Harshil Patel  
Production Manager  
M: +353 894563037  
E: [harshil@gobia.com](mailto:harshil@gobia.com)

## **Customers :**

### **Pharmaceutical Products Manufacturer**

- Allopathic Medicines
- Herbal Medicines
- Ayurvedic Medicines
- Food and Nutritional Supplements etc.

### **Food and Beverages Manufacturer**

- Juices and Squashes
- Milk products
- Mineral Water
- Edible oil
- Sausages etc.

### **Cosmetic Manufacturer**

- Shampoo & Conditioners
- Hair and other oils
- Body lotions
- Liquid soaps & different washes

### **Agro Chemical Manufacturers**

- Pesticides & Herbicides
- Hormones etc

### **Lube Oil Manufacturers**

**Any other industry for liquid packaging application**



## Markets :



**In India kb Associates is a leading brand all over the industry having market share more than 20% currently.**

**We have been supplying our products to more than 20 countries like USA, Romania, Israel, Uganda, Pakistan, Bangladesh, Nepal, Ghana, Kenya, Nigeria, Tanzania, Sudan, Congo, UAE, Syria, Iraq etc.**

**Empowering Liquid Packaging**

## **Q & S**

### **Quality :**

Pursuing highest standards and passing through stringent stage wise quality checks, kb associates produces a product that can optimize customer's production. Products of high quality standards withstands GMP & CE norms.

### **Services :**

A team of qualified and experienced engineers is always on their toes to provide any technical services to the customers round the clock. This ensures the utmost satisfaction of each customer, therefore an unbeaten faith of their in kb associates.

**Empowering Liquid Packaging**

**Valued Clients:**



**Empowering Liquid Packaging**

**Thank You.**